

K

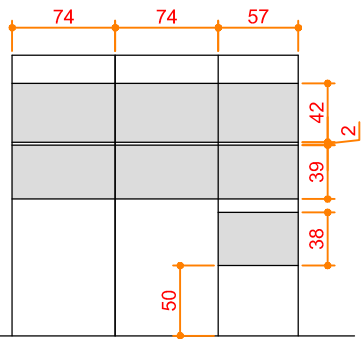

L

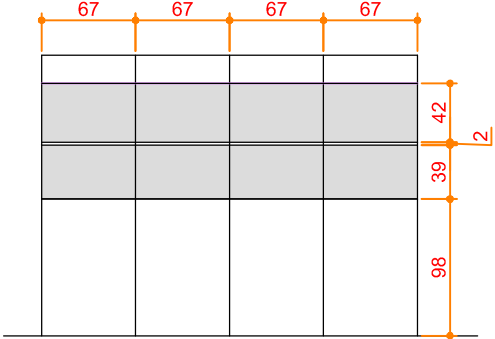

M

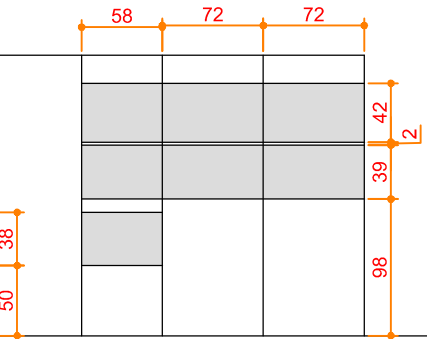
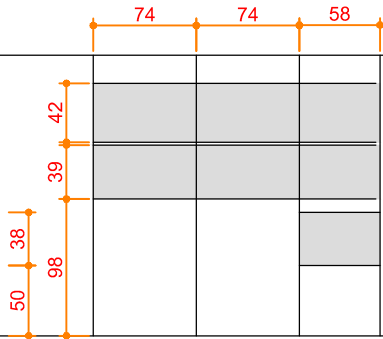
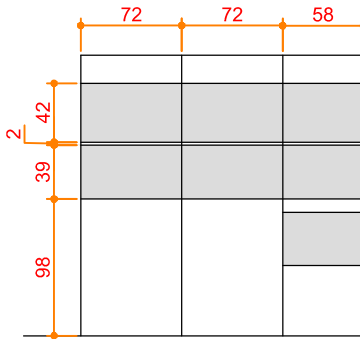
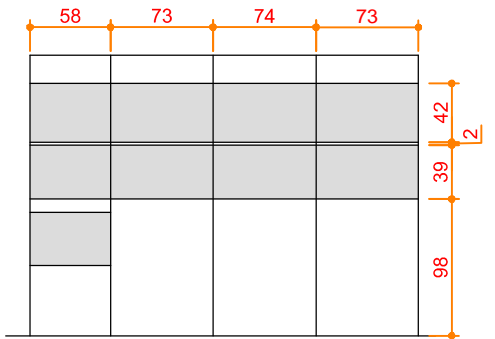

O

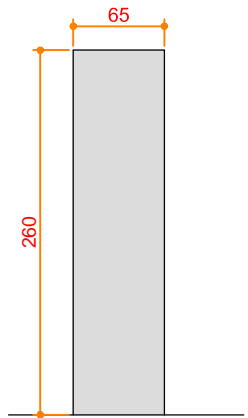

P

NOTA: VERIFICAR MEDIDAS EN OBRA